

# endrich news

www.endrich.com

## OUR PRODUCT OF THE MONTH: PRESSURE SENSORS AND TRANSMITTERS FROM MICRO SENSOR

NEW  
SUPPLIER!

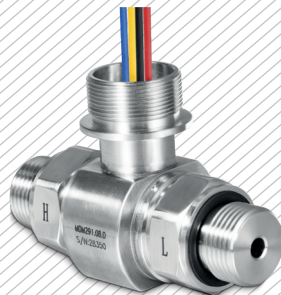

*Differential Pressure Sensors*



*Basic Piezoresistive Pressure Sensors*



*Pressure Transmitters*



*Differential Pressure Transmitters*

### FEATURES

- Basic piezoresistive pressure sensors ranges from 70 mbar to 1000 bar
- Small size pressure sensors diameter ranges from 12.6 mm to 19 mm
- Anti-corrosive pressure sensors diaphragm can be tantalum, titanium, hastelloy C and stainless steel 316 L
- Differential pressure sensors from 350 mbar to 35 bar is an OEM silicon pressure sensor based on piezoresistive principle
- Pressure transmitters ranges from 70 bar to 1000 bar, outputs analog 4 mA – 20 mA DC and voltage signals 0V – 10V, 0.5V – 4.5V, 0V – 5V, 1V – 5V are possible
- Differential pressure transmitters for low range pressure measurement for air and gases



Contact for information: Mr. Deuschle · phone: +49 7452 6007-929 · e-mail: w.deuschle@endrich.com

## NJL5830R – NEW REFLECTIVE-TYPE OPTOELECTRONIC SENSOR FOR TOUCHLESS PUSHBUTTONS

HAVE A LOOK

The NJL5830R is a reflective-type optoelectronic sensor that integrates a high output power infrared LED and a receiver photo IC in an unique package.

This sensor enables a 'key press' to be detected before the key is even touched. In this way, contactless operation can be achieved without direct human contact with the control panel or the buttons. The contactless actuation of buttons on devices in all areas of life prevents bacterial and viral infections and contributes as well to an improvement in hygiene.

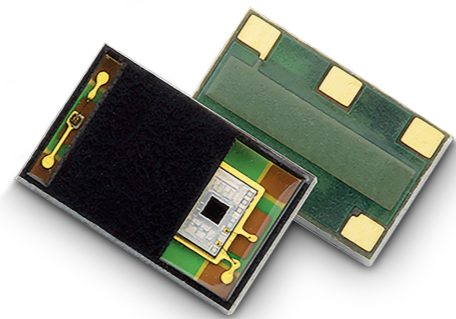

is trademark of New Japan Radio Co., Ltd

By internal automatically modulating the IR signal interference with neighboring sensors can be prevented so that entire keypads can be realized in this way. Hence the NJL5830R can not only be used for individual pushbuttons, but is also suitable for all types of control panels that are to be operated without direct touch. Furthermore the sensor is very resistant to ambient light and therefore the NJL5830R is also perfect for the contactless actuation of buttons for outdoor equipment.

### APPLICATIONS

- Operation switches
- Control panels
- Facilities and equipment with operation switches and operation panels like
- Vending machines
- Elevators
- Ticket vending machines
- Toilets

### FEATURES

- Existing pushbuttons can be operated without contact
- Support for adjacent pushbutton operation
- Digital output (normally off type)
- Small and thin package: 3.6 x 5.8 x 1.2 mm
- Operating voltage: 5.0 V

- Operating temperature range: -30 °C to +70 °C
- Lead free reflow soldering support: 260 °C, 2 cycle
- Lead free, halogen free
- RoHS directive compliance

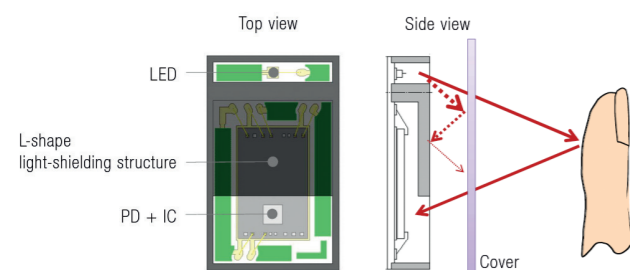

The detection distance may vary depending on the built-in structure and cover

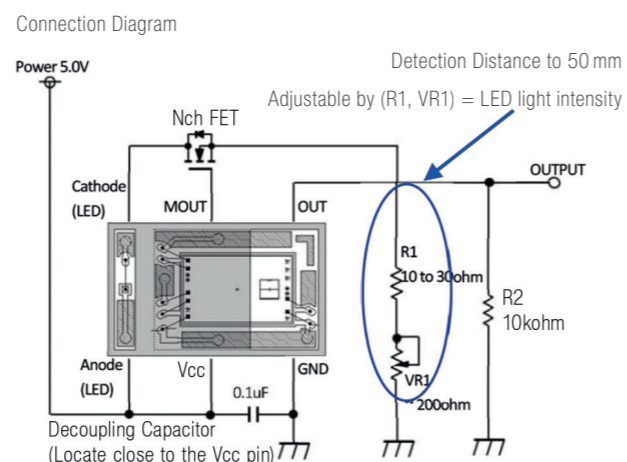

## NJR4266F2A3 SHORT-RANGE RADAR SENSOR MODULE FOR CONTACTLESS SWITCH APPLICATIONS

HAVE A LOOK

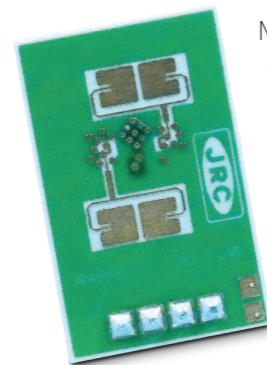

NJR offers with the NJR4266 series a variety of digital 24 GHz radio wave type sensor modules for different applications. The members of the family provide a range of 7-13 m depending on the antenna design. All 24 GHz doppler modules incorporates a built-in signal processing unit and a microcontroller. It features extremely low power consumption and competitive price compared to previous radar solutions. In ECO mode, they can even be counted in battery-powered applications, which was not typical of radars before.

Youngest member of the family is the new NJR4266F2A3, an intelligent human motion detection device optimized for short range detection. It has been specially optimized for a distance of 20 cm to 80 cm in order to detect simple hand

movements at this distance in front of a control surface. The switching level can be adjusted in the range of cm, the properties of the radar allow the device to be placed behind an unbreakable plastic cover, thus even the implementation of robust, vandal-proof outdoor solutions.

It incorporates the antenna, a 24 GHz band microwave circuit with signal processing circuit in a 17.2 x 27.3 x 5.2 mm low profile package. The detection range can be adjusted using a simple external potentiometer. A signal is output when movement is detected.

The module has excellent signal processing to avoid false detection even in outdoor usage. Compared to optical solutions, the sensor has the advantage that it can be hidden behind a non-metallic panel (e.g. plastic), thus even the realisation of robust, vandal-proof public contactless switch applications are possible.

### FEATURES

- Motion sensor using the 24 GHz microwave doppler principle
- Antenna, microwave RF circuit, IF amp, MCU and voltage regulator are integrated in a low-profile package (17.2 x 27.3 x 5.2 mm)
- Signal processing software for continuous acquisition
- Low-power-consumption ECO mode: Minimum 1.9 mA @ 3.3 V
- Random noise reduction in case of false detection
- Reduction of mutual interference
- Short-distance detection algorithm for contact-less switch
- Certification: CE (for EU)

### APPLICATIONS

- Any kind of simple contactless hand movements detection
- Traffic light button
- Door opener
- Light switch
- Toilet (automatic cleaning)



## TEMPERATURE COMPENSATION ATTENUATOR

Gas amplifier for the use of high-frequency amplified circuit has a characteristic that quantity of amplification decreases along with the increase of temperature. On the other hand, temperature compensation attenuator has a characteristic

that quantity of attenuation increases along with the increase of temperature. By connecting temperature compensation attenuator with amplifier in series, completed circuit is not required, temperature compensation will be realized.

### FEATURES

- Attenuation value changes along with temperature
- Wide frequency and better characteristic
- Small SMT type (2.0 x 1.2 mm)
- Realization of temperature characteristic by adjustment of thermistor characteristic

### APPLICATIONS

- Base station
- Radio communication
- Drone
- Laboratory measurement equipment
- Circuit protection by high voltage

SIZE	ATTENUATION VALUE	ATTENUATION VALUE	VSWR	THERMAL SENSITIVE CHARACTERISTIC
6 G (2.00 x 1.25 mm)	1-4 dB (1 dB Step)	±0.5 dB (@ 1 GHz, @ 25 °C)	<1.5 (@ 1 GHz, @ 25 °C)	N1-N9

IMPEDANCE	OPERATING FREQUENCY	RATED POWER	OPERATING TEMPERATURE	PACKAGING
50 Ω	DC-6 GHz	63 mW	-40 °C to +125 °C	180 reel 1000 or 5000 pcs

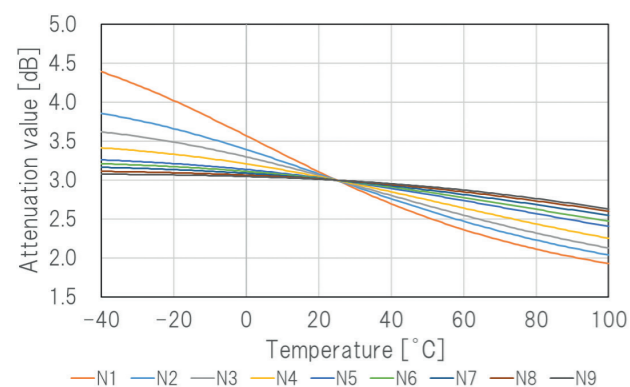

Temperature Coefficient of Attenuation

### CHARACTERISTIC

- Size 2.0 x 1.2 x 0.6 mm
- Sensing: 3 dB
- Circuit type:  $\pi$
- Impedance C: 50 Ω

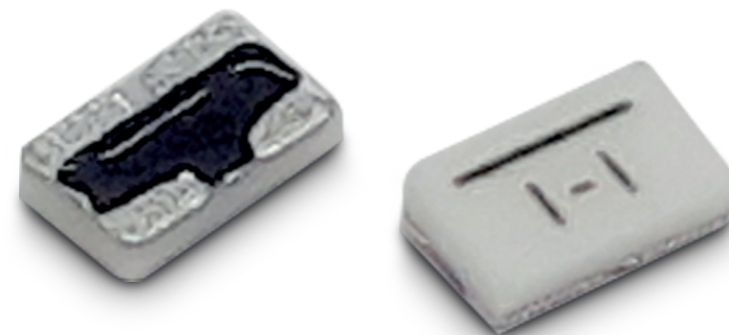

## PRESSURE SENSORS AND TRANSMITTERS FROM MICRO SENSOR

NEW SUPPLIER!

As a well-known sensor and monitoring product solutions provider, Micro Sensor has been committed to the development and manufacturing of reliable pressure sensors, transmitters, electromagnetic flow meters and wireless devices for 50 years.

Since the 1970s, Micro Sensor has engaged in the research and development of pressure sensors and transmitters designed around piezoresistive measurement principles. Using its rich experience, Micro Sensor can offer tailored solutions for different applications across a wide range of industries. We have provided intelligent systems to sectors as diverse as industrial automation, hybrid and electric vehicles, oil and gas, marine, energy and utilities, communications, and many others.

As the first one who self-designed and produced piezoresistive pressure sensors in China, being the world top-class sensing and measuring specialist is always our mission. Micro Sensor Co. Ltd. focuses on technics development, mass production and technical services in industrial and control areas, providing specified product solutions of fluid media measurement for customers over 90 countries in process control, smart manufacture, smart city, precise industries, etc.



### APPLICATIONS

- Process control
- Tank monitoring
- Agriculture irrigation
- Industrial gases
- Food and beverage
- HVAC and telemetry
- Hydropower plant applications

### FEATURES

- Basic piezoresistive pressure sensors ranges from 70 mbar to 1000 bar
- Small size pressure sensors diameter ranges from 12.6 mm to 19.0 mm
- Anti-corrosive pressure sensors diaphragm can be tantalum, titanium, hastelloy C and stainless steel 316 L
- Differential pressure sensors from 350 mbar to 35 bar is an OEM silicon pressure sensor based on piezoresistive principle
- Pressure transmitters ranges from 70 mbar to 1000 bar, outputs analog 4 mA – 20 mA DC and voltage signals 0 V – 10 V, 0.5 V – 4.5 V, 0 V – 5 V, 1 V – 5 V are possible
- Digital pressure transmitters ranges from 70 mbar to 1000 bar, output digital I<sup>2</sup>C, RS485, MODBUS and HART signals
- Differential pressure transmitters for low range pressure measurement for air and gases
- Wireless pressure transmitters can be equipped with a various network including NB-IoT / 4G





## IP68 WATERPROOF TEMPERATURE SENSORS

HAVE A LOOK

TTO Series was designed and dedicated especially for hard environmental conditions.

High humidity, frequent process of refrigeration and thawing, or water can easily damage most of the conventional sensors. Although those difficult conditions are not a problem for TTO Series, due to usage of overmoulding technology that assures very good barrier against moisture.

### APPLICATIONS

- Refrigerators and freezers
- Cooling cabinets
- Air conditioning
- Underfloor heating
- Boilers and heat pumps
- Climate control systems
- Industrial process control

### FEATURES

- Excellent insulation against moisture
- Degree of waterproof protection IP68
- Overmoulded tip diameters from 3.5 mm to 6.5 mm
- Available with steel cap for better mechanical protection
- Excellent resistance to UV (black insulation)
- ROHS compliant and halogen free
- Wide range of R/T characteristics
- Marking possible on request
- Cable remains flexible at minimum design temperature
- Wide range of sensing elements: NTC, PT100/500/1000, KTY, PTC etc

SPECIFICATION	
TEMPERATURE RANGE	-50 °C to +105 °C (continuous), version up to +150 °C is now available
TIGHT RESISTANCE TOLERANCE	±0.1 °C, ±0.2 °C, or 1 % to 5 %
BETA (25/85) VALUE	from 3187 K to 4262 K
BETA TOLERANCE	from ±0.3 % to ±5 %
CABLE	0.3 mm <sup>2</sup> stranded copper, VDE approved
CABLE LENGTH	from 100 mm to 100 m (others available)
INSULATION RESISTANCE	100 MOhm at 1000 VDC
DIELECTRIC STRENGTH	3750 V AC



## MEMS OSCILLATORS FOR INDUSTRIAL APPLICATIONS

HAVE A LOOK

Whether you're building medical devices, space shuttles, railways, or factory machinery, timing is critical. If timing fails:

- Robotic surgeries could be compromised or even stop in the middle of a procedure
- An airplane's landing gear may not descend at the right time
- An earthquake detection system may fail to alert residents nearby

Industrial equipment is exposed to vibration, shock, and high temperatures. That's a challenging environment for quartz timing devices. MEMS timing solutions are designed to perform better and perform longer in these extreme conditions.

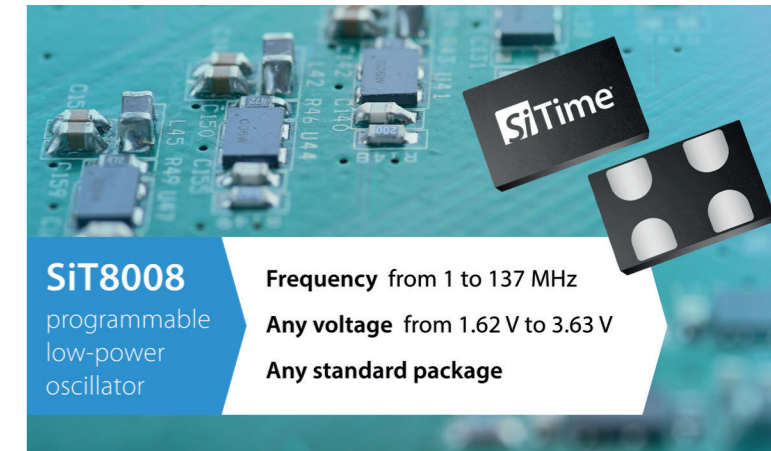

### ✓ SiTime continues to offer unprecedented flexibility

now with continuous supply voltage from 3.3 V down to 1.8 V in the popular SiT1602, SiT8008, and SiT8009 oscillators

### ✓ Up to 30x more reliable than quartz

FIT rate: < 2, MTBF: 1.2 billion hours

### ✓ Best-in-class stability under high temperature

20 ppm frequency stability over -55 °C to +125 °C

In addition the continuous supply voltage allows customers to use the same device for multiple designs, reducing the SKU count and maximizing the versatility of their inventory. Consolidating to one device also reduces the expense necessary for qualification, saving time and resources.

### FEATURES

- Millions of frequencies
- In-system programmability
- Spread spectrum

### APPLICATIONS

- Ideal for DSC, DVC, DVR, IP CAM, SSD, GPON, EPON, etc
- Ideal for high-speed serial protocols such as: USB, SATA, SAS, firewire, 100 M/1 G/10 G ethernet, etc.

## MEMS OSCILLATORS FOR INDUSTRIAL APPLICATIONS

STANDARD TEMPERATURE OSCILLATORS	SiT1602	SiT8008	SiT80098
OSCILLATOR TYPE	XO-SE		
FREQUENCY	52 stand. frequencies	1 MHz to 110 MHz any frequency	115 MHz to 137 MHz any frequency
FREQUENCY STABILITY	±20 ppm, ±25 ppm, ±50 ppm		
OPERATING TEMPERATURE RANGE	-20 °C to +70 °C, -40 °C to +85 °C		
OUTPUT TYPE	LVCMOS		
PACKAGE TYPE	2.0 x 1.6 mm <sup>2</sup> , 2.5 x 2.0 mm <sup>2</sup> , 3.2 x 2.5 mm <sup>2</sup> , 5.0 x 3.2 mm <sup>2</sup> , 7.0 x 5.0 mm <sup>2</sup>		
FEATURES	Field programmable		
VOLTAGE SUPPLY	1.8V, 2.5V to 3.3V, 1.8V to 3.3V		
FLEXEDGE™ RISE / FALL TIME	Yes		

HIGH TEMPERATURE OSCILLATORS	SiT1618	SiT1619	SiT8920	SiT89211
OSCILLATOR TYPE	XO-SE			
FREQUENCY	1 MHz to 110 MHz any frequency	115 MHz to 137 MHz any frequency	1 MHz to 110 MHz any frequency	115 MHz to 137 MHz any frequency
FREQUENCY STABILITY	±20 ppm, ±25 ppm, ±50 ppm			
OPERATING TEMPERATURE RANGE	-40 °C to +105 °C, -40 °C to +125 °C		+40 °C to +105 °C, -40 °C to +125 °C	
OUTPUT TYPE	LVCMOS			
PACKAGE TYPE	2.0 x 1.6 mm <sup>2</sup> , 2.5 x 2.0 mm <sup>2</sup> , 3.2 x 2.5 mm <sup>2</sup> , 5.0 x 3.2 mm <sup>2</sup> , 7.0 x 5.0 mm <sup>2</sup>			
FEATURES	Field programmable			
VOLTAGE SUPPLY	1.8V, 2.5V to 3.3V			
FLEXEDGE™ RISE / FALL TIME	Yes			

Contact for information: Mr. Gensler · phone: +49 7452 6007-31 · e-mail: a.gensler@endrich.com

### HEADQUARTERS

Endrich Bauelemente Vertriebs GmbH  
P.O.Box 1251 · 72192 Nagold, Germany  
T +49 7452 6007-0  
F +49 7452 6007-70  
E endrich@endrich.com  
www.endrich.com

### SALES OFFICES IN EUROPE

**France**  
Paris:  
T +33 1 86653215  
france@endrich.com

**Spain**  
Barcelona:  
+34 93 2173144  
spain@endrich.com

**Austria & Slovenia**  
Gmunden:  
+43 1 6652525  
austria@endrich.com

**Hungary**  
Budapest:  
T +36 1 2974191  
hungary@endrich.com

**Lyon:**  
T +33 1 86653215  
france2@endrich.com

**Bulgaria**  
Sofia:  
bulgaria@endrich.com

**Romania**  
Timisoara:  
romania@endrich.com

**Switzerland – Novitronic**  
Zurich:  
T +41 44 30691-91  
info@novitronic.ch