

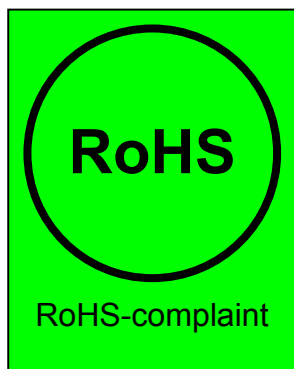

Piezoelectric Ceramic Devices

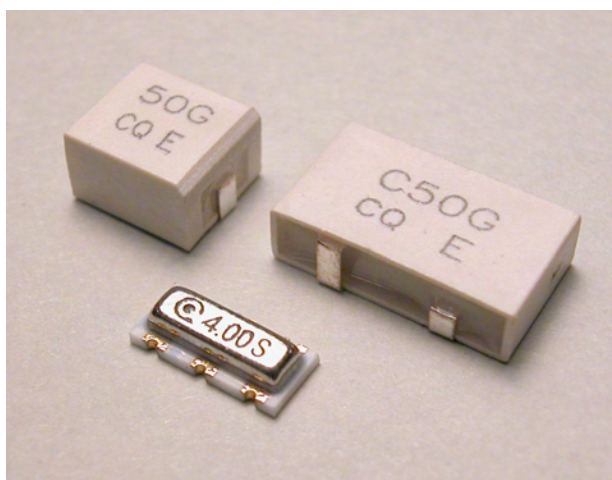

No.	SGS Report No.	Report Date



Attention

Products of Chequers Electronic (China) Limited (hereafter “Chequers”) shall not be used within any critical systems, which require especially high reliability. Critical systems mean, if such systems fail, one can reasonably expect that failure in such systems will result in damage to a third party’s life, body or property. In case products of Chequers must be used in critical systems, please consult with our sales representatives before using products from Chequers.

When using CQ products...

1. Do not apply voltage exceeding the rated voltage of components
2. Be certain not to operate outside the recommended operating temperature range of components
3. Be careful of soldering temperature and duration of components when soldering
4. Do not place soldering iron on the body of components
5. Be careful not to subject the terminals or leads of components to excessive force
6. Pay attention to the type of flux cleaning solvents that may damage components
7. Please contact our sales representatives or engineers before using the products specified in this specification sheet for the following equipment, which require high reliability, and if such equipment fails, which might damage to a third party’s life, body or property.
 - (i) Aerospace equipment
 - (ii) Medical equipment
 - (iii) Power plant equipment
 - (iv) Transportation equipment
 - (v) Traffic control equipment
 - (vi) Disaster control / prevention equipment
 - (vii) Undersea navigational equipment
 - (viii) Data-processing equipment
 - (ix) Or equipment that requires similar complexity and / or reliability of above equipment
8. Product specifications in this specification sheet are as of the date that is printed on, and they are for reference only. They are subject to change or discontinue without prior notice. Please check with our sales representative or engineers for details.
9. When using our products, please do not exceed the requirements and conditions specified in this specification sheet.
10. Should there be any doubt when using our products, please consult our sales representative or engineers before using our products.



Content

*Ceramic Resonator SMD and THT	2 ~ 60 MHz
*Ceramic Resonator SMD and THT (EOL not for new development)	455 ~ 1000 kHz
*Ceramic Filter SMD	455/450 kHz
*Ceramic Filter THT	455/450 kHz
*Ceramic Discriminator SMD and THT (AM Application)	455 kHz
*Ceramic Filter and Discriminator SMD and THT (FM Application)	10.7/10.64 MHz
*Ceramic Filter and Trap (TV Application)	4.5/5.5/6.0/6.5 MHz
*Printed Band Pass Filter (FM Application)	76 ~ 108 MHz



Ceramic Resonator (MHz)

RoHS Compliant
Directive 2002/95/EC

REACH Compliant
(15 SVHCs)
Regulation (EC)
No. 1907/2006

Dimension

ZTACC□MG / ZTACP□MG / ZTCC□MG / ZTTC□MG

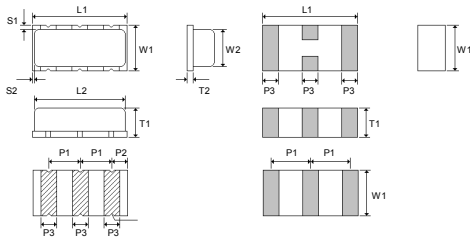

	Dimension	
	ZTACC ZTTC	ZTACP ZTTC
L1	7.4±0.2	6.0±0.2
L2	6.7 max.	-
W1	3.4±0.2	3.0±0.2
W2	2.2 max.	-
T1	1.8±0.2	1.7±0.2
T2	0.6±0.05	-
S1	0.4±0.3	-
S2	0.1±0.2	-
P1	2.5±0.2	2.4±0.2
P2	1.2±0.1	-
P3	1.2±0.2	1.2±0.2

ZTACS□MT/MX / ZTACV□MT/MX / ZTCS□MT/MX / ZTTCV□MT/MX

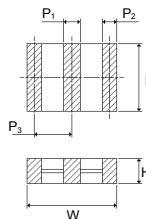

	Dimension	
	ZTACS ZTCS	ZTACV ZTTCV
L	4.7±0.2	3.7±0.2
W	4.1±0.2	3.1±0.2
H	1.9±0.2*	1.7±0.3*
P1	1.0±0.4	0.9±0.2
P2	0.8±0.4	0.7±0.2
P3	1.95±0.2	1.5±0.2

Note:
* Maximum height
- Center terminal is omitted for ZTACS / ZTACV ceramic resonator.

Unit: mm

ZTACC/ZTCC

Note:
Center terminal is omitted for ZTACC/ZTCC ceramic resonator.

Tolerance: ±0.3mm
Unit: mm

ZTACR□MG / ZTACE□MG / ZTTCR□MG / ZTTC□MG

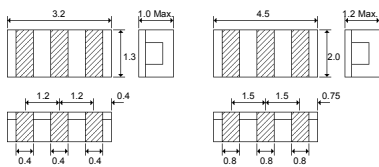

Note:
Center terminal is omitted for ZTACR / ZTACE ceramic resonator.

Tolerance: ±0.2mm
Unit: mm

ZTACE/ZTTC

ZTACR/ZTTCR

ZTACW / ZTTCW

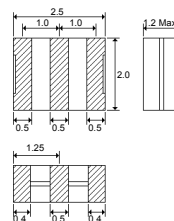

Note:
Center terminal is omitted for ZTACW ceramic resonator.

Tolerance: ±0.2mm
Unit: mm

ZTA□MT / ZTA□MX / ZTAWS□MG / ZTALS□MG

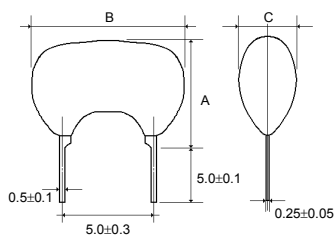

ZTAWS□MG / ZTALS□MG	
A	5.5 Max.
B	10.0 Max.
C	4.0 Max.

	ZTA□MT	ZTA□MX
A	10.0 Max.	10.0 Max. (12.00~23.99MHz) 7.5 Max. (24.00~31.99MHz) 6.5 Max. (32.00~60.00MHz)
B	10.0 Max.	10.0 Max.
C	5.0 Max.	5.0 Max.

Tolerance: ±0.3mm
Unit: mm

ZTT□MT / ZTT□MX / ZTTWS□MG / ZTTLS□MG

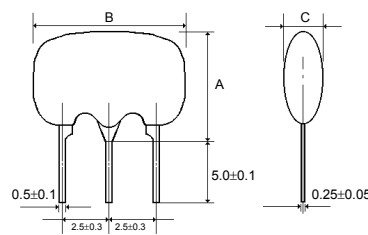

ZTTWS□MG / ZTTLS□MG	
A	5.5 Max.
B	10.0 Max.
C	4.0 Max.

	ZTT□MT	ZTT□MX
A	10.0 Max.	12.0 Max. (12.00~13.00MHz) 10.0 Max. (13.01~60.00MHz)
B	10.0 Max.	10.0 Max.
C	5.0 Max.	5.0 Max.

Tolerance: ±0.3mm
Unit: mm

ZTARS□MG

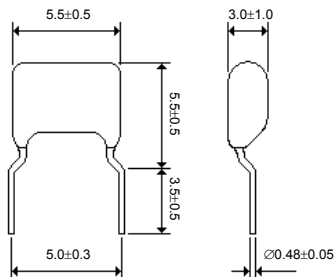

Unit: mm

ZTTRS□MG

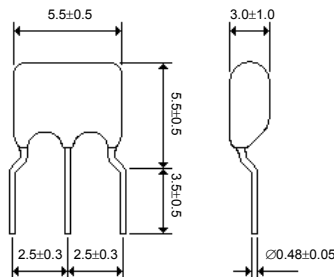

Unit: mm



● Electrical Specifications of ZTACC / ZTCC / ZTACP / ZTTC

Part Number	Frequency Range (MHz)	Frequency Tolerance (%)	Temperature Stability (%)	Operating Temperature Range (°C)	Aging Rate (%)
ZTACC□MG / ZTCC□MG	2.00 ~ 8.00	±0.3, ±0.5	±0.3	-25 ~ +85	±0.5
ZTACP□MG / ZTTC□MG	2.00 ~ 8.00	±0.3, ±0.5	±0.3	-25 ~ +85	±0.5

¹ For other frequencies or specifications, please consult with our sales representatives for details.

² For typical and available built-in capacitance, please consult with our sales representative.

³ Withstanding voltage: DC100V (5 seconds max.)

⁴ Insulation resistance: 5x10⁸Ω min. (DC10V)

● Electrical Specifications of ZTACS / ZTACV / ZTCS / ZTCV

Part Number	Frequency Range (MHz)	Frequency Tolerance (%)	Temperature Stability (%)	Operating Temperature Range (°C)	Aging Rate (%)
ZTACS□MT / ZTCS□MT	6.00 ~ 13.00	±0.5	±0.3	-25 ~ +85	±0.5
ZTACS□MX / ZTCS□MX	13.01 ~ 60.00	±0.5	±0.4	-25 ~ +85	±0.5
ZTACV□MT / ZTCV□MT	8.00 ~ 13.00	±0.5	±0.3	-25 ~ +85	±0.5
ZTACV□MX / ZTCV□MX	16.00 ~ 60.00	±0.5	±0.3	-25 ~ +85	±0.5

¹ For other frequencies or specifications, please consult with our sales representatives for details.

² For typical and available built-in capacitance, please consult with our sales representative.

³ Withstanding voltage: DC100V (5 seconds max.)

⁴ Insulation resistance: 5x10⁸Ω min. (DC10V)

● Electrical Specifications of ZTACR / ZTCR

Part Number	Frequency Range (MHz)	Frequency Tolerance (%)	Temperature Stability (%)	Operating Temperature Range (°C)	Aging Rate (%)
ZTACR□MG / ZTCR□MG	4.00 ~ 8.00	±0.5	±0.3	-25 ~ +85	±0.5

¹ For other frequencies or specifications, please consult with our sales representatives for details.

² For typical and available built-in capacitance, please consult with our sales representative.

³ Withstanding voltage: DC100V (5 seconds max.)

⁴ Insulation resistance: 5x10⁸Ω min. (DC10V)

● Electrical Specifications of ZTACE / ZTCE

Part Number	Frequency Range (MHz)	Frequency Tolerance (%)	Temperature Stability (%)	Operating Temperature Range (°C)	Aging Rate (%)
ZTACE□MG / ZTCE□MG	8.00 ~ 12.00	±0.5	±0.3	-25 ~ +85	±0.5

¹ For other frequencies or specifications, please consult with our sales representatives for details.

² For typical and available built-in capacitance, please consult with our sales representative.

³ Withstanding voltage: DC100V (5 seconds max.)

⁴ Insulation resistance: 5x10⁸Ω min. (DC10V)

● Electrical Specifications of ZTACW / ZTCW

Part Number	Frequency Range (MHz)	Frequency Tolerance (%)	Temperature Stability (%)	Operating Temperature Range (°C)	Aging Rate (%)
ZTACW□MX / ZTCW□MX	20.00 ~ 60.00	±0.5	±0.3	-25 ~ +85	±0.5

¹ For other frequencies or specifications, please consult with our sales representatives for details.

² For typical and available built-in capacitance, please consult with our sales representative.

³ Withstanding voltage: DC100V (5 seconds max.)

⁴ Insulation resistance: 5x10⁸Ω min. (DC10V)

● Electrical Specifications of ZTA / ZTALS / ZTARS / ZTAW / ZTT / ZTTLS / ZTTRS / ZTTWS

Part Number	Frequency Range (MHz)	Frequency Tolerance (%)	Temperature Stability (%)	Operating Temperature Range (°C)	Aging Rate (%)
ZTAW□MG / ZTTWS□MG	1.79 ~ 6.00	±0.3, ±0.5	±0.3	-25 ~ +85	±0.5
ZTALS□MG / ZTTLS□MG	3.00 ~ 8.00	±0.3, ±0.5	±0.3	-25 ~ +85	±0.5
ZTARS□MG / ZTTRS□MG	3.00 ~ 12.50	±0.3, ±0.5	±0.3	-25 ~ +85	±0.5
ZTARS□MX / ZTTRS□MX	16.00 ~ 60.00	±0.3, ±0.5	±0.3	-25 ~ +85	±0.5
ZTA□MT / ZTT□MT	6.00 ~ 13.00	±0.5	±0.3	-25 ~ +85	±0.5
ZTA□MX / ZTT□MX	12.00 ~ 60.00	±0.5	±0.3	-25 ~ +85	±0.5

¹ For other frequencies or specifications, please consult with our sales representatives for details.

² For typical and available built-in capacitance, please consult with our sales representative.

³ Withstanding voltage: DC100V (5 seconds max.)

⁴ Insulation resistance: 5x10⁸Ω min. (DC10V)



Ceramic Resonator (KHz)

RoHS Compliant
Directive 2002/95/EC

REACH Compliant
(15 SVHCs)
Regulation (EC)
No. 1907/2006

• Dimension

ZTBF

Freq. (KHz)	ZTBF455E-TF ZTBF500E-TF	ZTBF921.6J-TF ZTBF1.00MJ-TF
Dimension		
A	9.0±0.5	6.0±0.5
B	7.0±0.5	5.9±0.5
C	5.0±0.3	2.5±0.3
D	0.6±0.2	0.6±0.2
E	0.9±0.2	0.8±0.2
F	3.5±0.5	2.2±0.5
G	0.9±0.3	0.6±0.3
H	1.5±0.3	1.0±0.3
J	0.15±0.05	0.12±0.05

Tolerance: ±0.3mm
Unit: mm

ZTB

Freq. (KHz)	ZTB455E ZTB500E	ZTB1.00MJ
Dimension		
A	3.5	2.2
B	7.0	5.9
C	5.0	2.5
D	1.0	0.9
E	5.0	3.5
F	0.6	0.6
G	5.0	2.5
H	0.15±0.05	0.12±0.05

Tolerance: ±0.3mm
Unit: mm

• Electrical Specifications of ZTBF

Part Number	Frequency (KHz)	Frequency Tolerance	Temperature Stability (-20°C~+80°C, %)	Aging Rate (10 years, %)
ZTBF455E-TF	455	±2.0KHz	±0.3	±0.5
ZTBF500E-TF	500	±2.0KHz	±0.3	±0.5
ZTBF921.6J-TF	921.6	±0.5%	±0.3	±0.5
ZTBF1.00MJ-TF	1000	±0.5%	±0.3	±0.5

- For other frequencies or specifications, please consult with our sales representatives for details.

• Electrical Specifications of ZTB

Part Number	Frequency (KHz)	Frequency Tolerance	Temperature Stability (-20°C~+80°C, %)	Aging Rate (10 years, %)
ZTB455E	455	±2.0KHz	±0.3	±0.5
ZTB500E	500	±2.0KHz	±0.3	±0.5
ZTB1.00MJ	1000	±0.5%	±0.3	±0.5

- For other frequencies or specifications, please consult with our sales representatives for details.



Ceramic Filter (450/455KHz, SMD Type)

RoHS Compliant
Directive 2002/95/EC

REACH Compliant
(15 SVHCs)
Regulation (EC)
No. 1907/2006

• Dimension

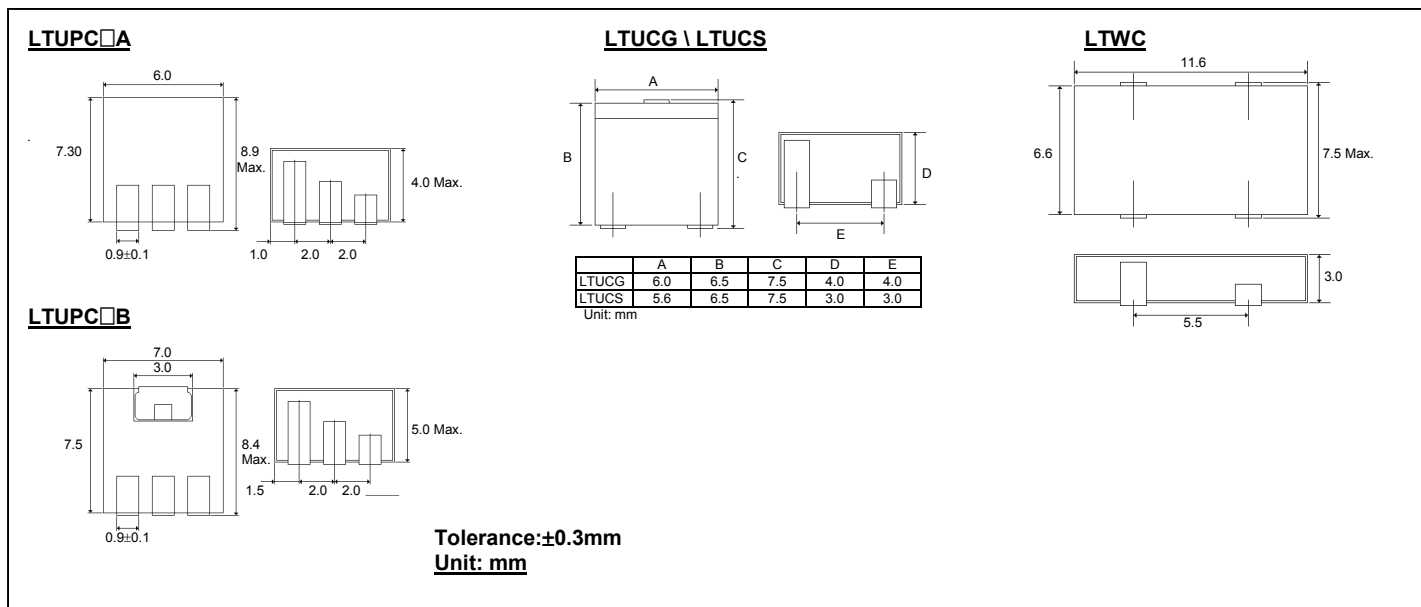

• Electrical Specifications of LTUCG and LTUCS

Part Number	Center Frequency (Center of 6dB Bandwidth)	Bandwidth		Stop Band Att. ±100KHz	Insertion Loss at Min. Loss Point	Ripple	Input/output Impedance
		6dB	40dB				
	KHz	KHz Min.	KHz Max.	dB Min.	dB Max.	dB Max.	Ω
LTUCG455B, LTUCS455B	$f_o \pm 1.5$	±15.0	±35.0	25.0	4.0	2.0 (±9KHz)	1000
LTUCG455C, LTUCS455C	$f_o \pm 1.5$	±12.5	±28.0	25.0	4.0	2.0 (±8KHz)	1000
LTUCG455D, LTUCS455D	$f_o \pm 1.5$	±10.0	±20.0	27.0 (LTUCG) 25.0 (LTUCS)	4.0 (LTUCG) 6.0 (LTUCS)	2.0 (±7KHz)	1500 (LTUCG) 1000 (LTUCS)
LTUCG455E, LTUCS455E	$f_o \pm 1.5$	±7.5	±15.0	27.0	6.0	2.0 (±5KHz)	1500
LTUCG455F, LTUCS455F	$f_o \pm 1.5$	±6.0	±12.5	27.0	6.0	2.0 (±4KHz)	1500
LTUCG455G, LTUCS455G	$f_o \pm 1.5$	±4.5	±10.0	25.0	6.0	2.0 (±3KHz)	1500
LTUCG455H, LTUCS455H	$f_o \pm 1.5$	±3.0	±9.0	25.0	6.0	2.0 (±2KHz)	1500

- For other frequencies or specifications, please consult with our sales representatives for details.
- Center frequency of 450KHz is also available.
- For safety purposes, connect the output of filters to the IF amplifier through a D.C. blocking capacitor. Avoid applying a direct current to the output of ceramic filters.

• Electrical Specifications of LTUPC□A and LTUPC□B

Part Number	Center Frequency (Center of 6dB Bandwidth)	Bandwidth		Stop Band Att. ±100KHz	Insertion Loss at Min. Loss Point	Ripple	Input/output Impedance
		6dB	40dB				
	KHz	KHz Min.	KHz Max.	dB Min.	dB Max.	dB Max.	Ω
LTUPC455BA, LTUPC455BB	$f_o \pm 1.5$	±15.0	±35.0	25.0	4.0	2.0 (±9KHz)	1000 (LTUPC□A) 1500 (LTUPC□B)
LTUPC455CA, LTUPC455CB	$f_o \pm 1.5$	±12.5	±28.0	25.0	4.0	2.0 (±8KHz)	1000 (LTUPC□A) 1500 (LTUPC□B)
LTUPC455DA, LTUPC455DB	$f_o \pm 1.5$	±10.0	±20.0	27.0	4.0	2.0 (±7KHz)	1500
LTUPC455EA, LTUPC455EB	$f_o \pm 1.5$	±7.5	±15.0	27.0	6.0	2.0 (±5KHz)	1500
LTUPC455FA, LTUPC455FB	$f_o \pm 1.5$	±6.0	±12.5	27.0	6.0	2.0 (±4KHz)	1500
LTUPC455GA, LTUPC455GB	$f_o \pm 1.5$	±4.5	±10.0	25.0	6.0	2.0 (±3KHz)	1500
LTUPC455HA, LTUPC455HB	$f_o \pm 1.5$	±3.0	±9.0	25.0	6.0	2.0 (±2KHz)	1500

- For other frequencies or specifications, please consult with our sales representatives for details.
- Center frequency of 450KHz is also available.
- For safety purposes, connect the output of filters to the IF amplifier through a D.C. blocking capacitor. Avoid applying a direct current to the output of ceramic filters.



• Electrical Specifications of LTWC

Part Number	Center Frequency (Center of 6dB Bandwidth) KHz	Bandwidth			Stop Band Att. $\pm 100\text{KHz}$ dB Min.	Insertion Loss at Min. Loss Point dB Max.	Ripple dB Max.	Spurious Response (0.1~1.0MHz) dB Max.	GDT Ripple Deviation $\mu\text{Sec Max.}$	Input/output Impedance Ω
		3dB KHz Min.	6dB KHz Min.	50dB KHz Max.						
LTWC455B	$f_0 \pm 1.5$	± 10.0	± 15.0	± 35.0	45.0	6.0	3.0 ($\pm 10\text{KHz}$)	15.0	50 ($\pm 10\text{KHz}$)	1000
LTWC455C	$f_0 \pm 1.5$	± 8.0	± 12.5	± 28.0	45.0	6.0	3.0 ($\pm 8\text{KHz}$)	15.0	50 ($\pm 8\text{KHz}$)	1000
LTWC455D	$f_0 \pm 1.5$	± 7.0	± 10.0	± 20.0	50.0	4.0	3.0 ($\pm 7\text{KHz}$)	20.0	50 ($\pm 7\text{KHz}$)	1500
LTWC455E	$f_0 \pm 1.5$	± 5.5	± 7.5	± 15.0	50.0	4.0	3.0 ($\pm 5\text{KHz}$)	20.0	50 ($\pm 5\text{KHz}$)	1500
LTWC455F	$f_0 \pm 1.5$	± 4.0	± 6.0	± 12.0	47.0	6.0	3.0 ($\pm 4\text{KHz}$)	20.0	50 ($\pm 4\text{KHz}$)	1500
LTWC455G	$f_0 \pm 1.5$	± 3.0	± 4.5	± 10.0	47.0	6.0	2.0 ($\pm 3\text{KHz}$)	20.0	50 ($\pm 3\text{KHz}$)	1500
LTWC455H	$f_0 \pm 1.5$	± 2.0	± 3.0	± 9.5	47.0	6.0	2.0 ($\pm 2\text{KHz}$)	20.0	50 ($\pm 2\text{KHz}$)	1500
LTWC455IT	$f_0 \pm 1.0$	-	± 2.5	± 6.0	60.0	6.0	2.0 ($\pm 1\text{KHz}$)	20.0	-	1500

NEW! For other frequencies or specifications, please consult with our sales representatives for details.
Center frequency of 450KHz is also available.
For safety purposes, connect the output of filters to the IF amplifier through a D.C. blocking capacitor. Avoid applying a direct current to the output of ceramic filters.



Ceramic Filter (450/455KHz, Leaded Type)

RoHS Compliant
Directive 2002/95/EC

REACH Compliant
(15 SVHCs)
Regulation (EC)
No. 1907/2006

• Dimension

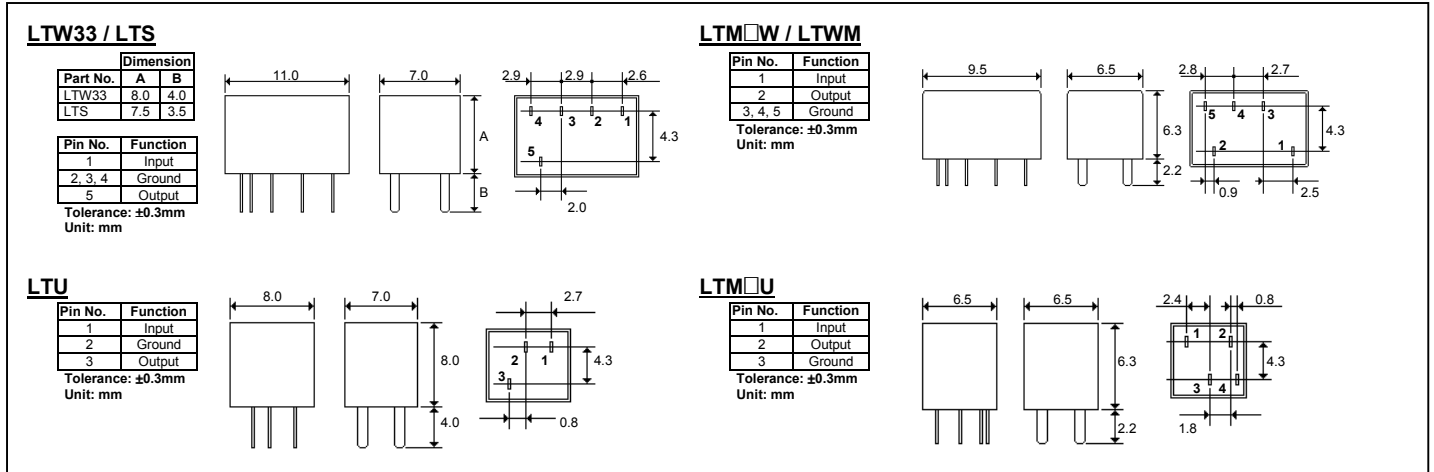

• Electrical Specifications of LTW33 / LTS / LTM□W / LTWM

Part Number	Insertion Loss	Pass Band Ripple	Bandwidth		Stop Band Att. ±100KHz	Input/output Impedance
			6dB	50dB		
			dB Max.	dB Max.		
LTW33-455B / LTS455BW / LTM455BW	4	2	±15.0	±30.0	40.0	1500
LTW33-455C / LTS455CW / LTM455CW	4	2	±12.5	±24.0	40.0	1500
LTW33-455D / LTS455DW / LTM455DW	4	2	±10.0	±20.0	40.0	1500
LTW33-455E / LTS455EW / LTM455EW	6	2	±7.5	±15.0	40.0	1500
LTW33-455F / LTS455FW / LTM455FW	6	2	±6.0	±12.5	40.0	2000
LTW33-455G / LTS455GW / LTM455GW	6	2	±4.5	±10.0	40.0	2000
LTW33-455H / LTS455HW / LTM455HW	6	2	±3.0	±9.0	40.0	2000
LTW33-455I / LTS455IW / LTM455IW	6	2	±2.0	±7.5	40.0	2000
LTW33-455HT / LTS455HTW / LTWM455HT	6	2	±3.0	±9.0	60.0	2000
LTW33-455IT / LTS455ITW / LTWM455IT	6	2	±2.0	±7.5	60.0	2000

- Other frequencies and specifications are also available upon request, please consult with our sales representatives for details.
- Center frequency of 450KHz is also available.
- For safety purposes, connect the output of filters to the IF amplifier through a D.C. blocking capacitor. Avoid applying a direct current to the output of ceramic filters.

• Electrical Specifications of LTU / LTM□U / LTUM

Part Number	Insertion Loss	Pass Band Ripple	Bandwidth		Stop Band Att. ±100KHz	Input/output Impedance
			6dB	40dB		
			dB Max.	dB Max.		
LTU455B / LTM455BU	4	2	±15.0	±30.0	27.0	1500
LTU455C / LTM455CU	4	2	±12.5	±24.0	27.0	1500
LTU455D / LTM455DU	4	2	±10.0	±20.0	27.0	1500
LTU455E / LTM455EU	6	2	±7.5	±15.0	27.0	1500
LTU455F / LTM455FU	6	2	±6.0	±12.5	27.0	2000
LTU455G / LTM455GU	6	2	±4.5	±10.0	25.0	2000
LTU455H / LTM455HU	6	2	±3.0	±9.0	25.0	2000
LTU455I / LTM455IU	6	2	±2.0	±7.5	25.0	2000
LTU455HT / LTUM455HT	6	2	±3.0	±9.0	35.0	2000
LTU455IT / LTUM455IT	6	2	±2.0	±7.5	35.0	2000

- Other frequencies and specifications are also available upon request, please consult with our sales representatives for details.
- Center frequency of 450KHz is also available.
- For safety purposes, connect the output of filters to the IF amplifier through a D.C. blocking capacitor. Avoid applying a direct current to the output of ceramic filters.



Ceramic Discriminator (AM Applications)

RoHS Compliant
Directive 2002/95/EC

REACH Compliant
(15 SVHCs)
Regulation (EC)
No. 1907/2006

• Dimension

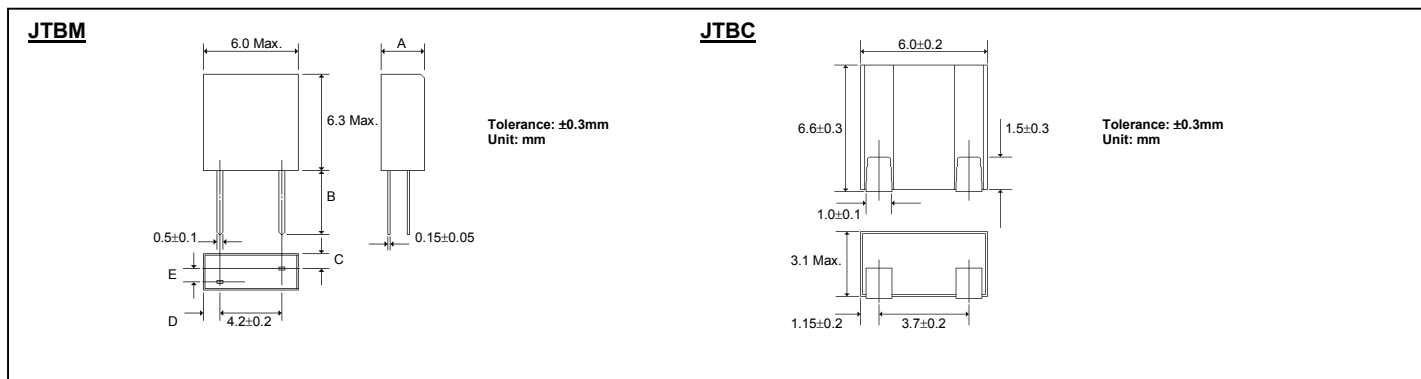

• Electrical Specifications of JTBM / JTBC

Part Number	Nominal Anti-Resonant Frequency (f _a)	Δf(f _a -f _r)	Resonant Resistance (R)	Static Capacitance (C ₀)	Recommended IC	Dimensions (Tolerance: ±0.3mm)			
						A	B	C	D
JTBM/JTBC455XC2	447±1.5KHz (Z =2.05KΩ)	463±1.5KHz (Z =10.0KΩ)		140pF±20%	TA8104	3.0	4.2	0.6	1.8
JTBM/JTBC455XC3	455±1.5KHz	46±5.0KHz	70Ω Max.	550pF±20%	CXA1184M	2.5	4.2	1.0	1.0

- JTBM / JTBC are available in: 450KHz or 455KHz

- For other frequencies or specifications, please consult with our sales representatives for details.

Part Number	Recovered Audio 3dB Bandwidth (from 455KHz)	Recovered Audio Output Voltage (at 455KHz)	Distortion (at 455KHz)	Recommended IC	Dimensions (Tolerance: ±0.3mm)			
					A	B	C	D
JTBM/JTBC455CX7	±4.0KHz Min.	340±60mV	3.0% Max.	MC3357	3.0	4.2	0.6	1.0
JTBM/JTBC455CX16	±4.0KHz Min.	185±40mV	2.0% Max.	MC3372	3.0	4.2	0.6	1.0
JTBM/JTBC455CX18	±3.0KHz Min.	180±40mV	2.0% Max.	MC3371	3.0	4.2	0.6	1.0
JTBM/JTBC455CX24	±4.0KHz Min.	100±40mV	2.0% Max.	TA31136	2.5	4.2	1.0	1.0
JTBM/JTBC455CX28	±4.0KHz Min.	40±20mV	3.0% Max.	TA31142	2.5	4.2	1.0	1.0
JTBM/JTBC455CX32	±4.0KHz Min.	40±20mV	3.0% Max.	TA31143	2.5	4.2	1.0	1.0
JTBM/JTBC455CX34	±4.0KHz Min.	65±20mV	2.5% Max.	MC13136	2.5	4.2	1.0	1.0
JTBM/JTBC455CX40	±4.0KHz Min.	40±20mV	3.0% Max.	TA31145	2.5	4.2	1.0	1.0
JTBM/JTBC455CX47	±4.0KHz Min.	40±20mV	3.0% Max.	TA31147F	2.5	4.2	1.0	1.0
JTBM/JTBC455CX49	±4.0KHz Min.	360±50mV	2.5% Max.	MC3357	3.0	4.2	0.6	1.0
JTBM/JTBC455CX50	±4.0KHz Min.	64±6.4mV	4.0% Max.	CXA3117N	2.5	4.2	1.0	1.0

- JTBM / JTBC are available in: 450KHz or 455KHz

- For other frequencies or specifications, please consult with our sales representatives for details.

Part Number	Recovered Audio Output Voltage (at 455KHz)	Difference of Voltage Between at 455±4.8KHz	Recommended IC	Dimensions (Tolerance: ±0.3mm)			
				A	B	C	D
JTBM/JTBC455CX54	165±20mV	170±20mV	TA3114D	2.5	4.0	1.0	1.0

- JTBM / JTBC are available in: 450KHz or 455KHz

- For other frequencies or specifications, please consult with our sales representatives for details.



Ceramic Filter and Discriminator (FM Applications)

RoHS Compliant
Directive 2002/95/EC

REACH Compliant
(15 SVHCs)
Regulation (EC)
No. 1907/2006

• Dimension

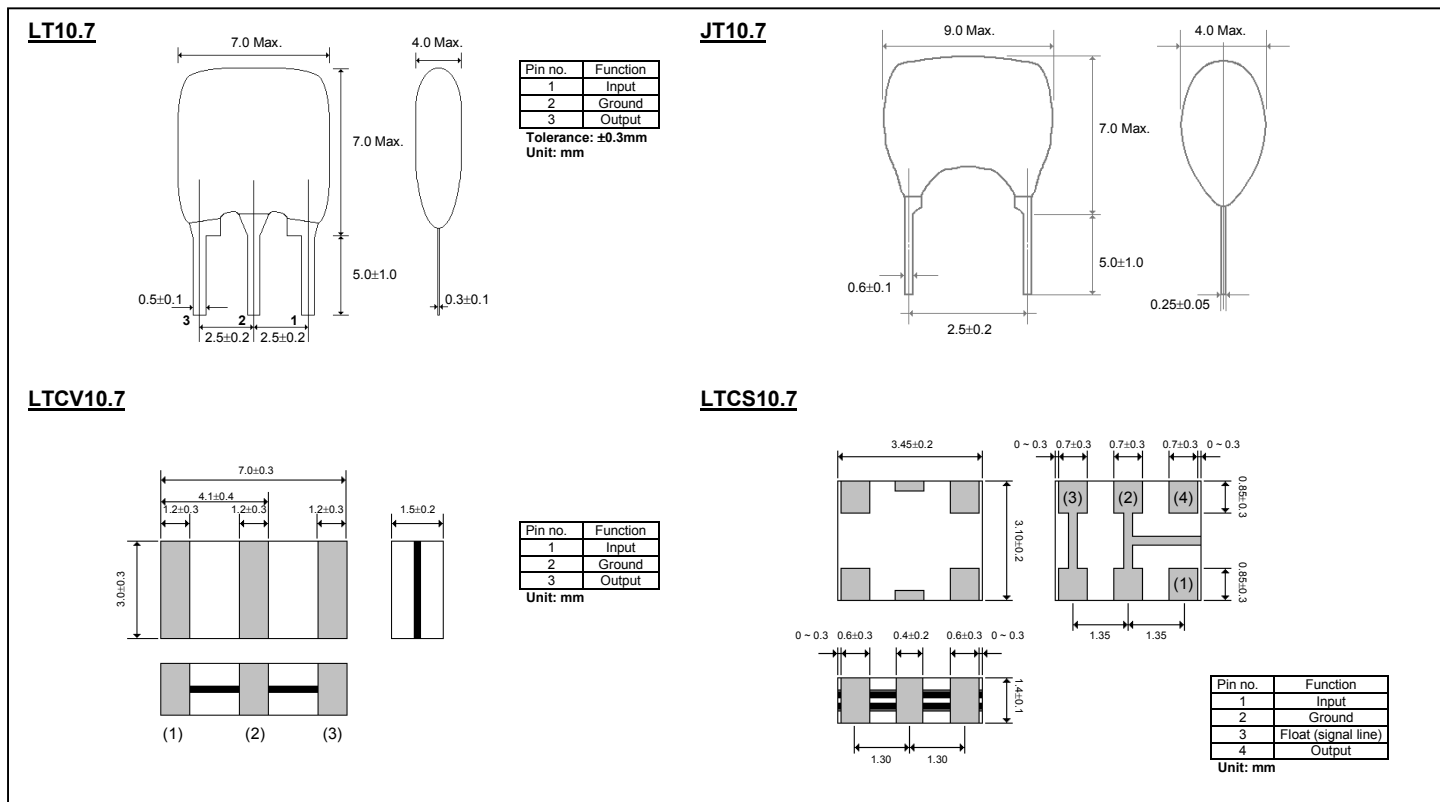

• Electrical Specifications of LT10.7

Part Number	Center Frequency (MHz)	3dB Bandwidth (KHz Min.)	20dB Bandwidth (KHz Max.)	Insertion Loss (dB Max.)	Response [9KHz~12KHz] (dB Min.)
LT10.7MA5	10.70 \pm 0.03	280.0 \pm 50.0	650.0	6.0	30.0
LT10.7MS2	10.70 \pm 0.03	230.0 \pm 50.0	600.0	6.0	40.0
LT10.7MS3	10.70 \pm 0.03	180.0 \pm 40.0	520.0	7.0	40.0
LT10.7MA5A10	10.70 \pm 0.03	280.0 \pm 50.0	590.0	2.5 \pm 2.0	30.0
LT10.7MS2A10	10.70 \pm 0.03	230.0 \pm 50.0	520.0	3.0 \pm 2.0	35.0
LT10.7MS3A10	10.70 \pm 0.03	180.0 \pm 40.0	470.0	3.5 \pm 1.5	35.0
LT10.7MJA10	10.70 \pm 0.03	150.0 \pm 40.0	360.0	4.5 \pm 2.0	35.0
LT10.7MA21	10.70 \pm 0.03	400 Min.	950.0	3.0 \pm 2.0	20.0
LT10.7MA19	10.70 \pm 0.03	fn \pm 175.0 Mn.	950.0	3.0 \pm 2.0	20.0
LT10.7MA20	10.70 \pm 0.03	330.0 \pm 50.0	680.0	4.0 \pm 2.0	30.0
LT10.7MHY	10.70 \pm 0.03	110.0 \pm 30.0	350.0	5.5 \pm 2.0	30.0
LT10.7MFP	10.70 \pm 0.03	20 Min.	95	6.0	24.0 (9.7 ~ 11.7MHz)
Specification	10.64 \pm 0.03MHz	10.67 \pm 0.03MHz	10.70 \pm 0.03MHz	10.73 \pm 0.03MHz	10.76 \pm 0.03MHz
Color dot	D Black	B Blue	A Red	C Orange	E White

¹ For other frequencies or specifications, please consult with our sales representatives for details.

² Input/output impedance: 330 Ω



● Electrical Specifications of LTCV10.7 / LTCS10.7

Part Number	Center Frequency (MHz)	3dB Bandwidth (KHz Min.)	20dB Bandwidth (KHz Max.)	Insertion Loss (dB Max.)	Response [9KHz~12KHz] (dB Min.)
LTCV10.7MHY	10.70±0.03	110.0±30.0	320.0	6.0±2.0	35.0
LTCV10.7MJ	10.70±0.03	150.0±40.0	380.0	5.5±2.0	35.0
LTCV10.7MS3	10.70±0.03	180.0±40.0	470.0	4.0±2.0	35.0
LTCV10.7MS2	10.70±0.03	230.0±50.0	510.0	3.5±2.0	35.0
LTCV10.7MA5	10.70±0.03	280.0±50.0	590.0	3.0±2.0	35.0
LTCV10.7MA20	10.70±0.03	330.0±50.0	700.0	3.0±2.0	30.0
LTCV10.7MA19	10.70±0.03	fn±175.0 Min.	950	3.0±2.0	20.0 (5 ~ 15MHz)
LTCS10.7MS3	10.70±0.03	180.0±40.0	470.0	4.5±2.0	40.0
LTCS10.7MS2	10.70±0.03	230.0±50.0	510.0	3.5±2.0	40.0
LTCS10.7MA5	10.70±0.03	280.0±50.0	590.0	3.0±2.0	30.0
LTCS10.7MA20	10.70±0.03	330.0±50.0	700.0	3.0±2.0	30.0
Specification	10.64±0.03MHz	10.67±0.03MHz	10.70±0.03MHz	10.73±0.03MHz	10.76±0.03MHz
Color dot	D Black	B Blue	A Red	C Orange	E White

¹ For other frequencies or specifications, please consult with our sales representatives for details.

² Input/output impedance: 330Ω

● Electrical Specifications of JT10.7

Part Number	Center Frequency (MHz)	Recovered Audio 3dB BW (KHz Min.)	Recovered Audio Output (mV Min.)	Distortion (% Max.)	IC	Detection Method
JT10.70MC1	10.70±0.03	242.0	35.0	-	CX20091 CXA1019M	Quadrature
JT10.70MG1	10.70±0.03	-	-	1.0	CX20092	Quadrature
JT10.70MG16	10.70±0.03	300.0	Min. 60~ Max. 90	0.9	TA8122AN	Quadrature
JT10.70MG31	10.70±0.03	300.0	50.0	1.0	TA2003	Quadrature
JT10.70MG33	10.70±0.03	250.0	45.0	0.7	TA2007	Quadrature
JT10.70MG77	10.70±0.03	220.0	60.0	1.0	TA2111AN	Quadrature
JT10.70MG80	10.70±0.03	700.0	65.0	1.0	TA2104AFN	Quadrature
JT10.70MG82	10.70±0.03	320.0	90.0	0.8	TA2099N	Quadrature
JT10.70MG92	10.70±0.03	300.0	60.0	1.0	TA2132P	Quadrature
Specification	10.64±0.03MHz	10.67±0.03MHz	10.70±0.03MHz	10.73±0.03MHz	10.76±0.03MHz	
Color dot	D Black	B Blue	A Red	C Orange	E White	

- Other frequencies and specifications are also available upon request, please consult with our sales representatives.



Ceramic Filter and Trap (TV Applications)

RoHS Compliant
Directive 2002/95/EC

REACH Compliant
(15 SVHCs)
Regulation (EC)
No. 1907/2006

• Dimension

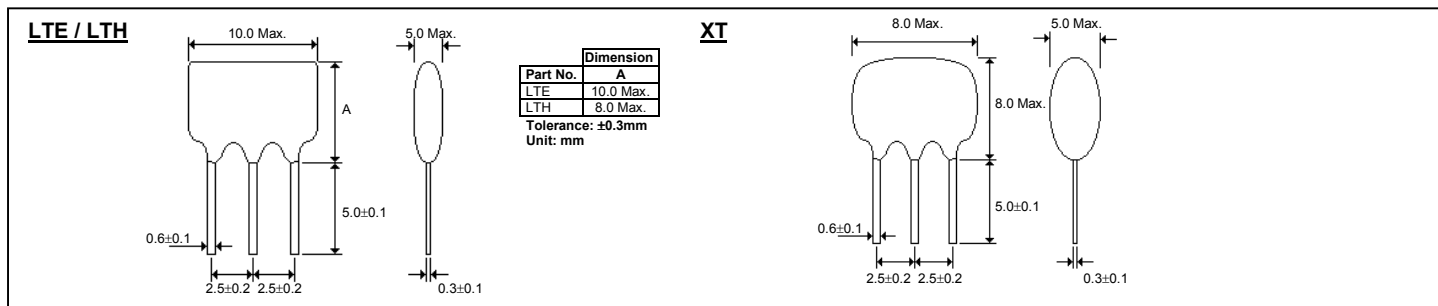

• Electrical Specifications of LTE / LTH

Part Number	Unit	LTE4.5MB	LTE5.5MB	LTE6.0MB	LTE6.5MB	LTH4.5MCB	LTH4.5MDB	LTH5.5MCB	LTH6.0MCB	LTH6.5MCB
Nominal Center Frequency (f _n)	MHz	4.500	5.500	6.000	6.500	4.500	4.500	5.500	6.000	6.500
3dB Bandwidth (from f _n)	KHz	±60 (±105)	±75 (±120)	±80 (±130)	±80 (±130)	±60 Min.	±70 Min.	±60 Min.	±60 Min.	±70 Min.
20dB Bandwidth	KHz	530 (420)	550 (470)	600 (500)	630 (530)	600 Max.	750 Max.	600 Max.	600 max	650 Max.
Insertion Loss (at Min. Loss Point)	dB	6 (4)	6 (3)	6 (2.5)	6 (2.5)	6.0 Max.	6.0 Max.	6.0 Max.	6.0 Max.	6.0 Max.
Spurious Response	dB	20 Min.	25 Min.	25 Min.	25 Min.	0 ~ 4.5MHz 30 Min.	0 ~ 4.5MHz 30 Min.	0 ~ 5.5MHz 30 Min.	0 ~ 6.0MHz 30 Min.	0 ~ 6.5MHz 30 Min.
		[4.5 ^{+0.8} _{-1.0} MHz]	[5.5±1.0MHz]	[6.0±1.0MHz]	[6.0±1.0MHz]	4.5 ~ 7.0MHz 15 Min.	4.5 ~ 5.7MHz 15 Min.	5.5 ~ 7.0MHz 15 Min.	6.0 ~ 7.5MHz 15 Min.	6.5 ~ 8.5MHz 15 Min.
						7.0 ~ 10.0MHz 30 Min.	5.7 ~ 10.0MHz 30 Min.	7.0 ~ 10.0MHz 30 Min.	7.5 ~ 10.0MHz 30 Min.	8.5 ~ 10.0MHz 30 Min.
Withstanding Voltage	V	DC 50V [1 Minute]								
Insulation Resistance	MΩ	100MΩ Min. [DC 100V]								
Operating Temperature	°C	-20°C ~ +80°C								
Input / Output Impedance	Ω	1000	600	470	470	1000	1000	600	470	470

- Other frequencies and specifications are also available upon request, please consult with our sales representatives.

• Electrical Specifications of XT

Part Number	Trap Attenuation at Nominal Center Frequency (dB Min.)	30dB Bandwidth (KHz Min.)
XT4.5MB	35 (45)	50 (80)
XT5.5MB		
XT6.0MB		70 (120)
XT6.5MB		
XT4.5MCB	30	40
XT5.5MCB		
XT6.0MCB		
XT6.5MCB		

- Other frequencies and specifications are also available upon request, please consult with our sales representatives.



Printed Band Pass Filter (FM Applications)

RoHS Compliant
Directive 2002/95/EC

REACH Compliant
(15 SVHCs)
Regulation (EC)
No. 1907/2006

• Dimension

LPF88A, LPF88B, LPF88A5, LPF76K

	LPF88A, LPF88B, LPF76K	LPF88A5
A	10.5 max.	7.5±0.3
B	5.0±0.3	5.0±0.3
C	6.0 max.	6.0 max.
D	7.0±1.5	7.0±1.5
E	2.5±0.3	2.5±0.3
F	2.5 max.	2.5 max.
G	0.2±0.1	0.3±0.1
H	0.5±0.1	0.5±0.1

Unit: mm

• Electrical characteristics

Specification	Pass Band	Insertion Loss	Attenuation	Input / output Impedance
	MHz	dB Max.	dB Min.	Ω
LPF88A	88 ~ 108	3.0 (88MHz ~ 108MHz)	20 (0MHz ~ 30MHz) 20 (170MHz ~ 250MHz)	75
LPF88A5	88 ~ 108	3.0 (88MHz ~ 108MHz) 3.5 (76MHz ~ 88MHz)	20 (0MHz ~ 30MHz) 20 (170MHz ~ 250MHz)	75
LPF76K	76 ~ 108	3.0 (76MHz ~ 108MHz)	15 (0MHz ~ 30MHz) 20 (170MHz ~ 250MHz)	75

- For other frequencies or specifications, please consult with our sales representatives for details.



This page intentionally left blank