

Pressure Transmitter

Suitable For General Industry

M20



Application

- Water Treatment
- Pump & Compressor
- Hydraulic Pressure & Pneumatic Device
- Mechanical Equipment
- Refrigerating System
- Measurement & Control
- Shipbuilding

Introduction

M20 pressure transmitter has precise design, highly integrated electrical structure, full digital temperature compensation and calibration, exquisite materials, good electromagnetic compatibility design. It is highly cost-effective while achieving high reliability.

M20 pressure transmitter has many international certifications. It has many different and flexible selections and options. It is suitable for various pressure monitoring and measurements in general industrial occasions. We also provide customized and OEM services.

Specification

- Pressure Type: Gauge, Absolute, Positive/Negative
- Pressure Range: 0kPa ~ 25kPa to 0MPa ~ 40MPa
- Electrical Connection:
 - Angular Connector DIN 175301-803A
 - Circular Aviation Plug M12×1(4pin) IEC 61076-2-101
- Accuracy: $\pm 0.25\%FS$
 $\pm 0.5\%FS$
- Process Connection: M20×1.5 ISO 9974-2/EN 837
 - G1/4A ISO 1179-2
 - NPT1/4 ANSI/ASME B1.20.1
 - R1/4 ISO 7
 - Other threads available on request
- Output: 4mA ~ 20mA DC
 - 0V ~ 5V DC
 - 1V ~ 5V DC
 - 0V ~ 10V DC
 - 0.5V ~ 4.5V DC
- Structure Specification: Full welded, adapted to breathable membrane
- Medium: Air, water, mixed oil or other fluid that can be compatible with wetted part

Certificate



Pressure Range

Gauge Pressure G							
Unit	Pressure Range	Overpressure	Code	Unit	Pressure Range	Overpressure	Code
kPa	0 ~ 25	50	343	mbar	0 ~ 250	500	543
	0 ~ 40	100	344		0 ~ 400	1000	544
	0 ~ 60	100	345		0 ~ 600	1000	545
	0 ~ 100	200	351		0 ~ 1000	2000	551
	0 ~ 160	300	352		0 ~ 1600	3000	552
	0 ~ 250	500	353		0 ~ 2500	5000	553
	0 ~ 400	1000	354		0 ~ 4000	10000	554
	0 ~ 600	1000	355		0 ~ 6000	10000	555
MPa	0 ~ 0.25	0.5	123	bar	0 ~ 2.5	5	233
	0 ~ 0.4	1	124		0 ~ 4	10	234
	0 ~ 0.6	1	125		0 ~ 6	10	235
	0 ~ 1	2	131		0 ~ 10	20	241
	0 ~ 1.6	3	132		0 ~ 16	30	242
	0 ~ 2.5	5	133		0 ~ 25	50	243
	0 ~ 4	10	134		0 ~ 40	100	244
	0 ~ 6	10	135		0 ~ 60	100	245
	0 ~ 10	15	141		0 ~ 100	150	251
	0 ~ 16	30	142		0 ~ 160	300	252
	0 ~ 25	37.5	143		0 ~ 250	375	253
	0 ~ 40	60	144		0 ~ 400	600	254

Absolute Pressure A							
Unit	Pressure Range	Overpressure	Code	Unit	Pressure Range	Overpressure	Code
kPa	0 ~ 25	50	343	mbar	0 ~ 250	500	543
	0 ~ 40	100	344		0 ~ 400	1000	544
	0 ~ 60	100	345		0 ~ 600	1000	545
	0 ~ 100	200	351		0 ~ 1000	2000	551
	0 ~ 160	300	352		0 ~ 1600	3000	552
	0 ~ 250	500	353		0 ~ 2500	5000	553
	0 ~ 400	1000	354		0 ~ 4000	10000	554
	0 ~ 600	1000	355		0 ~ 6000	10000	555
MPa	0 ~ 0.25	0.5	123	bar	0 ~ 2.5	5	233
	0 ~ 0.4	1	124		0 ~ 4	10	234
	0 ~ 0.6	1	125		0 ~ 6	10	235
	0 ~ 1	2	131		0 ~ 10	20	241
	0 ~ 1.6	3	132		0 ~ 16	30	242
	0 ~ 2.5	5	133		0 ~ 25	50	243

Pressure Range

Positive/Negative Pressure N						
Unit	Pressure Range	Overpressure	Code	Pressure Range	Overpressure	Code
kPa	-5 ~ + 20	±30	3A5	-50 ~ + 50	100	3AE
	-5 ~ + 25	±50	3A7	-60 ~ 0	100	315
	-15 ~ + 15	±30	3A6	-100 ~ 0	150	321
	-20 ~ + 20	±30	3A8	-100 ~ + 60	150	322
	-25 ~ 0	±50	313	-100 ~ + 150	300	323
	-25 ~ + 25	±50	3AA	-100 ~ + 300	500	324
	-30 ~ + 30	±50	3AC	-100 ~ + 500	1000	325
	-40 ~ 0	±100	314	-100 ~ + 900	2000	331
MPa	-0.015 ~ + 0.015	±0.03	1A6	-0.1 ~ 0	0.15	121
	-0.02 ~ + 0.02	±0.03	1A8	-0.1 ~ + 0.06	0.15	122
	-0.025 ~ 0	±0.05	113	-0.1 ~ + 0.15	0.3	123
	-0.025 ~ + 0.025	±0.05	1AA	-0.1 ~ + 0.3	0.5	124
	-0.03 ~ + 0.03	±0.05	1AC	-0.1 ~ + 0.5	1	125
	-0.04 ~ 0	±0.1	114	-0.1 ~ + 0.9	2	131
	-0.05 ~ + 0.05	0.1	1AE	-0.1 ~ + 1.5	3	132
	-0.06 ~ 0	0.1	115	-0.1 ~ + 2.4	5	133
mbar	-50 ~ + 200	±300	5A5	-500 ~ + 500	1000	5AE
	-50 ~ + 250	±500	5A7	-600 ~ 0	1000	515
	-150 ~ + 150	±300	5A6	-1000 ~ 0	1500	521
	-200 ~ + 200	±300	5A8	-1000 ~ + 600	1500	522
	-250 ~ 0	±500	513	-1000 ~ + 1500	3000	523
	-250 ~ + 250	±500	5AA	-1000 ~ + 3000	5000	524
	-300 ~ + 300	±500	5AC	-1000 ~ + 5000	10000	525
	-400 ~ 0	±1000	514	-1000 ~ + 9000	20000	531
bar	-0.15 ~ + 0.15	±0.3	2A6	-1 ~ 0	1.5	221
	-0.2 ~ + 0.2	±0.3	2A8	-1 ~ + 0.6	1.5	222
	-0.25 ~ 0	±0.5	213	-1 ~ + 1.5	3	223
	-0.25 ~ + 0.25	±0.5	2AA	-1 ~ + 3	5	224
	-0.3 ~ + 0.3	±0.5	2AC	-1 ~ + 5	10	225
	-0.4 ~ 0	±1	214	-1 ~ + 9	20	231
	-0.5 ~ + 0.5	1	2AE	-1 ~ + 15	30	232
	-0.6 ~ 0	1	215	-1 ~ + 24	50	233

If the pressure range you need is not in the table, please kindly contact us, or refer to the Pressure Unit Conversion Table.

Pressure Unit Conversion Table ISO 31-3

Standard Unit	Pa(N/m ²)	kPa	MPa	bar	mbar
1 Pa(N/m ²)	1	0.001	0.000001	0.00001	0.01
1 kPa	1000	1	0.001	0.01	10
1 MPa	1000000	1000	1	10	10000
1 bar	100000	100	0.1	1	1000
1 mbar	100	0.1	0.0001	0.001	1
1 mmH ₂ O	9.807	0.009807	0.000009807	0.00009807	0.09807
1 kg/cm ²	98070	98.07	0.0981	0.9807	980.7
1 atm	101300	101.3	0.1013	1.013	1013
1 mmHg	133.3	0.1333	0.001333	0.001333	1.333
1 psi	6895	6.895	0.006895	0.0689	68.948
Standard Unit	mmH ₂ O	kg/cm ²	atm	mmHg	psi
1 Pa(N/m ²)	0.102	0.0000102	0.000009869	0.007501	0.000145
1 kPa	101.9716	0.0102	0.009869	7.501	0.145
1 MPa	101972	10.2	9.869	7501	145.038
1 bar	10197	1.02	0.9869	750.1	14.5038
1 mbar	10.1972	0.00102	0.0009869	0.7501	0.0145
1 mmH ₂ O	1	0.0001	0.00009678	0.0734	0.001422
1 kg/cm ²	10000	1	0.9678	734.2	14.224
1 atm	10330	1.033	1	760.1	14.68
1 mmHg	13.62	0.001362	0.001316	1	0.0193
1 psi	704.3	0.0703	0.068	51.71	1

Output Signal

Type	Output	Code
Current(2-wire)	4 mA ~ 20mA DC	1
Voltage(3-wire)	0V ~ 5V DC	2
	1V ~ 5V DC	3
	0V ~ 10V DC	4
	0.5V ~ 4.5V DC	5
Ratio Voltage(3-wire)	0.5V ~ 4.5V DC	6

Load (Ω)

Current(2-wire) : ≤ (Power Supply-8V)/0.02 A

Voltage(3-wire) : >10 k

Power Supply

Output	Power Supply	Voltage Affect	Output Ripple
4mA ~ 20mA DC	8V ~ 30V DC	≤±0.1%FS	≤1%
0V ~ 5V DC	8V ~ 30V DC		
1V ~ 5V DC	8V ~ 30V DC		
0V ~ 10V DC	14V ~ 30V DC		
0.5V ~ 4.5V DC	8V ~ 30V DC		
	(5±0.05) V DC Ratio		

The power supply of the pressure transmitter should be the electrical connection that meets the standard of the 9.3 part of UL/EN/IEC 61010-1, UL/EN/IEC 60950-1 LPS or UL 1310/UL 1585(NEC or CEC)2 Class standard requirement.

If the pressure transmitter is used in where the altitude is higher than 2000m, the power supply should be workable normally under the certain condition.

Total Current Consumption

Current(2-wire): Signal current, 23mA(max.)

Voltage(3-wire): <8 mA

Current Output Mode(Load Resistor Range)

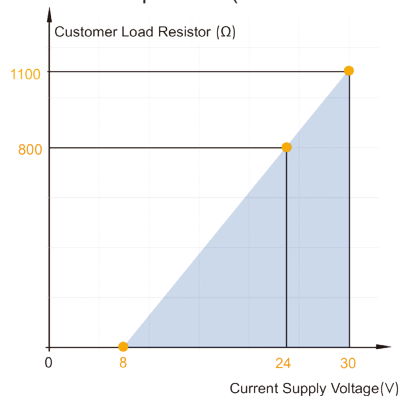

Output Current VS Pressure

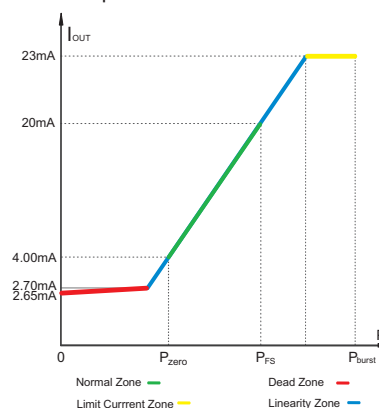

Accuracy

Confirm To IEC 61298-2		
Accuracy	$\leq \pm 0.25\%FS$	$\leq \pm 0.5\%FS$
Nonlinearity(BFSL)	$\leq \pm 0.2\%FS$	$\leq \pm 0.25\%FS$
Code	3	4
Confirm To JJG 882 (Chinese National Metrological Verification Regulations)		
Accuracy Class	0.25	0.5
Max. Error	$\leq \pm 0.25\%FS$	$\leq \pm 0.5\%FS$
Code	7	8

Specification

Hysteresis: $\leq 0.1\%FS$

Repeatability: $\leq 0.1\%FS$

Overpressure: See Table "Measuring Range"

Long-term Stability: $\leq \pm 0.1\%FS/year$ (typ.)

$\leq \pm 0.2\%FS/year$ (max.)

Response Time

Fluid Viscosity (<100 cSt): <4 ms

Gas: <35 ms

Operation Condition

Protection Class

IP65 IEC 60529

Atmospheric Pressure

86kPa ~ 106kPa

Vibration Environment

10g(@10Hz~2000Hz) IEC 60068-2-6

Shock Resistance

100g/11ms IEC 60068-2-27

Service Life

Within Measuring Range: >10 million times load cycle

Position Influence

$\leq \pm 0.1\%FS$

Environment Condition

Item	Temp. Range
Compensated Temp.	-10°C ~ 80°C
Medium Temp.	-30°C ~ 85°C
Environment Temp.	-30°C ~ 85°C
Storage Temp.	-40°C ~ 100°C

When the pressure transmitter is working normally, the measured medium should not be solid or semisolid;

The selected process connection sealing element will have limit on temp. range(please check the "Sealing Element").

Environment temp. Effect

Zero Temp. Coefficient: $\leq \pm 0.01\%FS/°C$ (typ.)

$\leq \pm 0.02\%FS/°C$ (max.)

Full Scale Temp. Coefficient: $\leq \pm 0.01\%FS/°C$ (typ.)

$\leq \pm 0.02\%FS/°C$ (max.)

Reference Condition IEC 61298-1

Temperature

15°C ~ 25°C

Relative Humidity

45% ~ 75%

Power Supply

(24±0.24)V DC; (5±0.05)V DC

Installation Direction

Pressure Port should be vertically downward



Electromagnetic Compatibility

Code	Test Item	Standard	Test Condition	Performance Class
1	Electrostatic Discharge Immunity	GB/T 17626.2/IEC 61000-4-2	6kV(Contact), 8kV(Air)	B
2	Radio-frequency Field	GB/T 17626.3/IEC 61000-4-3	10V/m; 80MHz ~ 6GHz; 80%AM(1kHz)	A
3	Power Frequency Magnetic Field	GB/T 17626.8/IEC 61000-4-8	Stable sustained magnetic field strength 50, 60Hz, 100A/m	A
4	Immunity of Electrical Fast Pulse Group	GB/T 17626.4/IEC 61000-4-4	±2kV; 5/50 Tr/Tk ns, 5kHz	B
5	Surge Immunity	GB/T 17626.5/IEC 61000-4-5	±2kV; 1.2/50(8/20) Tr/Th us	B
6	RF Induction Conduction Anti-harassment	GB/T 17626.6/IEC 61000-4-6	10V(150kHz ~ 80MHz); 80%AM(1kHz)	A

Note: Level A means that the performance is normal within the limit of technical specification.

Level B means that during testing, function or performance is temporarily reduced or lost, but can recover by itself, and the actual operation status, storage and data remain unchanged.

Certificate

Sign	Instruction	Country Or Region
	EU Declaration of Conformity EMC instruction of radiated interference and noise immunity standard for pressure devices	EU
	RoHS Conformity	EU
	Chemical Prevention Compliance	EU

Information of Manufacturer and Certificate

Sign	Instruction
	Chinese RoHS Conformity SJ/T 11364

Material

Wetted Part

Stainless Steel 316L

Sealing Element

FKM/NBR/Cuprum

Non-wetted Part

Stainless Steel 316L, Nylon

Pressure Transmission Medium

Silicone Oil

Process Connection

Standard	Pressure Port	Code
EN 837	G1/8 B	01
	G1/4 B	02
	G3/8 B	03
	G1/2 B	04
	M20×1.5	05
	G1/8 Female	06
	G1/4 Female	07
ISO 7	R1/4	10
	R3/8	11
	R1/2	12
ISO 1179-1	G1/4 Female	20
ISO 1179-2	G1/4 A	30
	G3/8 A	31
	G1/2 A	32
	G1/4 A + Pulse Snubber*	33
	G3/8 A + Pulse Snubber*	34
	G1/2 A + Pulse Snubber*	35
ISO 9974-2	M12×1.5	40
	M14×1.5	41
	M20×1.5	42
	M20×1.5 + Pulse Snubber*	43
ANSI/ASME B1.20.1	NPT1/8	50
	NPT1/4	51
	NPT1/2	52
	NPT1/8 Female	53
	NPT1/4 Female	54
	NPT1/2 Female	55
SAE J514 E	7/16-20UNF-74°Taper	60

Defaulted leading hole is of $\Phi 4\text{mm}$;
*Note: With $\phi 0.8\text{mm}$ Pulse Snubber.

Torque

The max. torque during the installation and uninstallation of the transmitter is about $20\text{N}\cdot\text{m} \sim 35\text{N}\cdot\text{m}$.

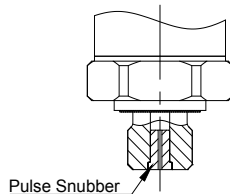

Sealing Element

Standard	Default	Applicable Temperature	Code
ISO 7/ANSI/SAE J514 E /ASMEB1.20.1			0
ISO 1179 / ISO 9974-2	NBR	-30°C ~ 85°C	1
ISO 1179 / ISO 9974-2	FKM	-10°C ~ 85°C	2
EN 837	Cuprum		3

Note: When the code is "0", the recommended sealing material is PTFE tape. The other material for each code is as above.

Electrical Connection

Item	Protection	Cable	Length	Code
Angular Connector DIN 175301-803A				
• With assorted connector	IP65			1
Circular Aviation Connector M12×1(4pin)IEC 61076-2-101				
• Without assorted connector				3
• Straight connector integrated with cable	IP65	MS903	2m	4

With Reverse Polarity Protection(Except for ratiometric output)

V+ vs GND

Wiring

DIN 175301-803 A Angular Connector				
	Definition	Code	2-wire	3-wire
	V+	V+	1	1
	V-	GND	2	2
	Output	VOUT	-	3
	Grounding	PE	⊕	⊕
M12×1(4pin) Circular Aviation Connector				
	Definition	Code	2-wire	3-wire
	V+	V+	4	4
	V-	GND	2	2
	Output	VOUT	-	3
	Grounding	PE	1	1
M12×1 Straight Connector Integrated with Cable (MS903)				
	Definition	Code	Line color	
	V+	V+	Brown	
	V-	GND	Blue	
	Output	VOUT	Black	
	Grounding	PE	Yellow green	

2-wire 4mA ~ 20mA Output

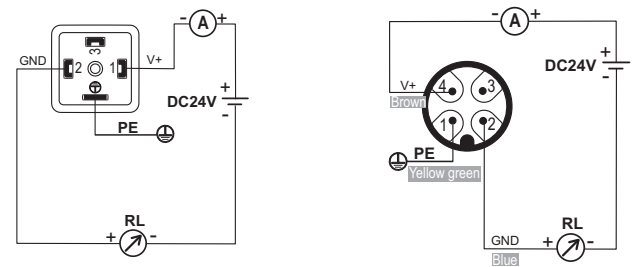

Note: The wire color is for reference only.

3-wire Voltage Output

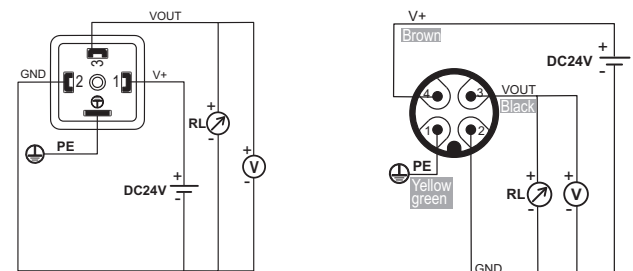

Note: The wire color is for reference only.

Dimension

Overall Dimension(Take G1/4A pressure port as an example. unit: mm)

Angular Connector A Type

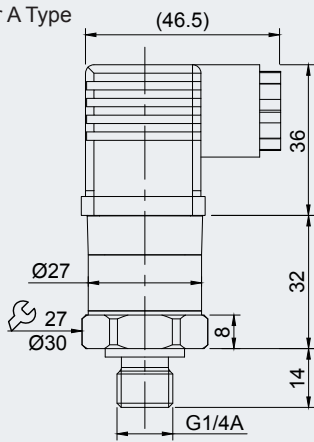

Weight: ≤135g

M12×1(4-pin) Plug Type

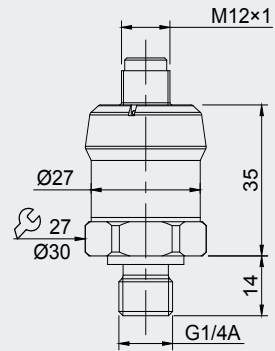

Weight: ≤95g

Process Connection(Unit: mm)

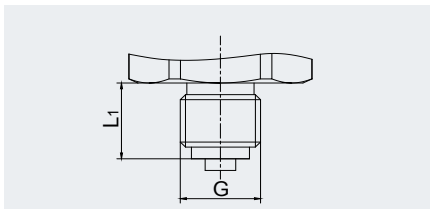

G	L1	Standard
G1/4 B	13	EN 837
G3/8 B	16	
G1/2 B	20	
M20×1.5	20	

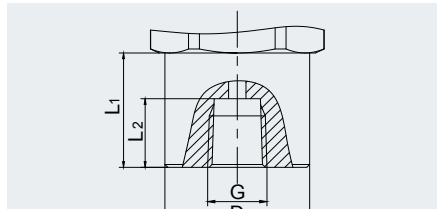

G	D1	L1	L2	Standard
NPT1/8	Φ25	20	12	ANSI/ASME B1.20.1
NPT1/4	Φ25	20	14	
NPT1/2	Φ25	25	19	

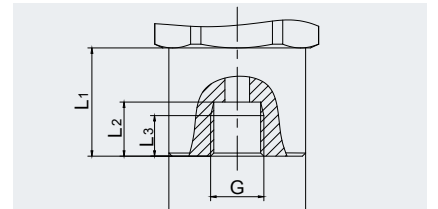

G	D1	L1	L2	L3	Standard
G1/8	Φ25	20	10	7.5	EN 837
G1/4	Φ25	20	13	10	

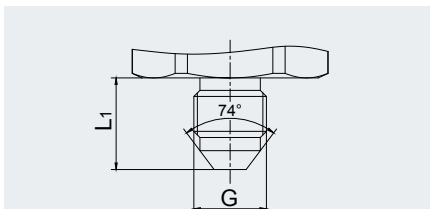

G	L1	Standard
7/16-20 UNF-74°Taper	14	SAE J514 E

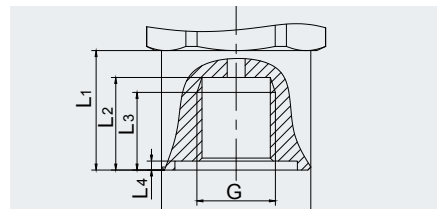

G	D1	L1	L2	L3	Standard
G1/4	Φ25	20	15.5	13	ISO 1179-1

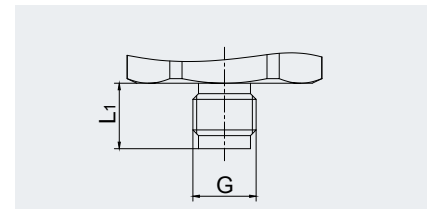

G	L1	Standard
G1/8 B	10	EN 837

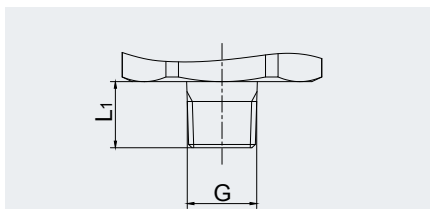

G	L1	Standard
NPT1/8	10	ANSI/ASME B1.20.1
NPT1/4	13	
NPT1/2	19	
R1/4	13	ISO 7
R3/8	15	
R1/2	19	

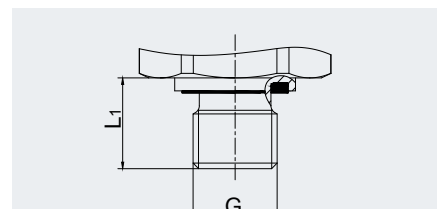

G	L1	Standard
G1/4 A	14	ISO 1179-2
G3/8 A	14.5	
G1/2 A	17	
M12×1.5	14	ISO 9974-2
M14×1.5	14	
M20×1.5	16.5	

Order Information

Model	Pressure Type	Range	Output	Accuracy	Process Connection	Sealing Element	Electrical Connection
-------	---------------	-------	--------	----------	--------------------	-----------------	-----------------------

Example:

M20	Gauge	0 ~ 2.5MPa	4mA ~ 20mA	0.5	G1/2 B	NBR	Hirschmann
-----	-------	------------	------------	-----	--------	-----	------------

Code Example:

M20	G	133	1	8	04	1	1
-----	---	-----	---	---	----	---	---

Optional Accessories

Cable Model	Specification	Cross sectional area of conductor	Material	Weight	Color
MS903	M12×1-Straight Connector-4-core-Length 2m	4×0.3mm ²	TPUR	≤ 90g	Black matte

If a metrological verification certificate (calibration certificate) of the ordered product is required, or there is any other special requirements, please kindly consult with our company.

Selection Assistant

Selection Website

[http:// guide.microsensor.cn](http://guide.microsensor.cn)

MICROSENSOR

Address: No. 18, Yingda Road, Baoji,
721006, Shaanxi, P.R.China
Tel.: +86-029-8834-6384 ext. 801
Fax: +86-029-8834-6384 ext. 823
Email: sales@microsensor.cn

Micro Sensor Co., Ltd. © All rights reserved. All data is only used for product descriptions and is not legally effective. The details of the relevant technical data may be changed due to further improvement. For details, please pay attention to the update of official website.